



Orange 5G Vision



Eric Hardouin, Orange Labs
Juillet 2018

The Orange vision of future networking: 5G

5G will provide all the means to access the Internet, including

- radio: existing (4G, Wi-Fi) and a new radio (NR)
- a convergent core network managing wireline and radio accesses (fibre, 4G, NR, Wi-Fi...)

5G will deliver more than connectivity

- new business models and value propositions
- enabled by a unified infrastructure integrating networking, computing and storage resources

For high performance and new capabilities



5G connectivity services

all delivered by the same network

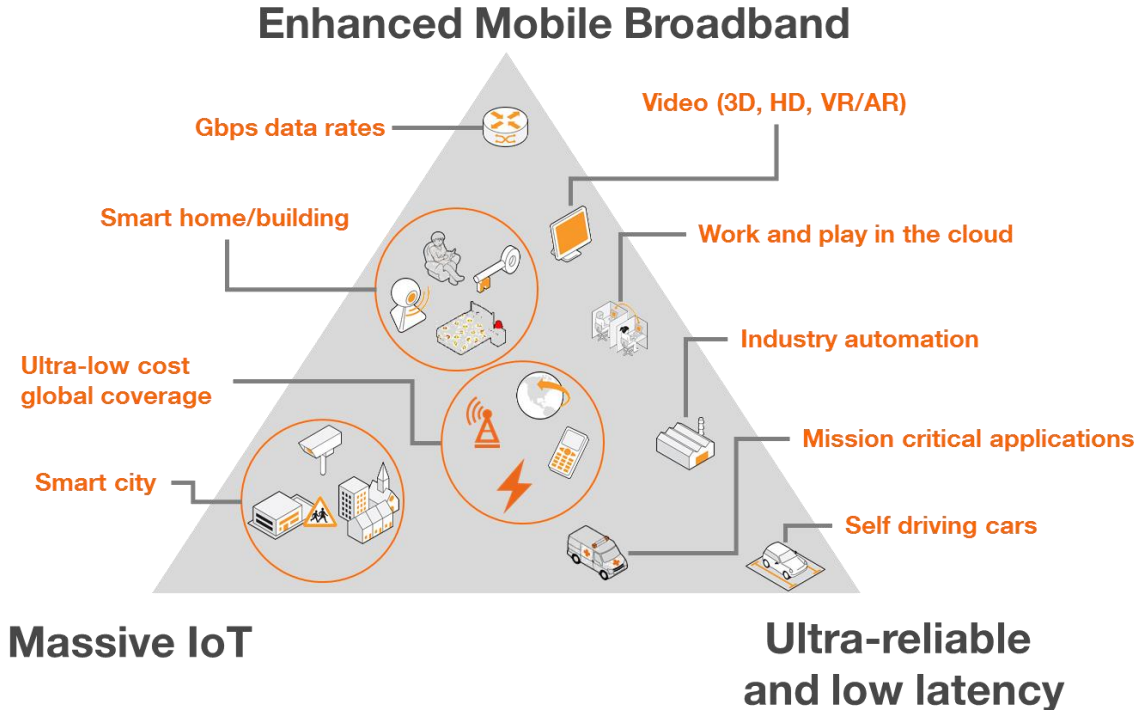

key expectations

- **ambient connectivity and higher minimum throughput:**
50 Mbps “everywhere”
- **higher capacity and experienced data rates**
Up to Gbps experienced rates
x10 spectral efficiency vs. 4G+
new cm/mmWave spectrum
- **expand the IoT for support of vertical industries**
99.999% reliability
1 to 10 ms latency
- **higher energy efficiency:**
minimise energy consumption
for a heavily increased traffic
- **enable ultra low-cost networks**
for digital inclusion

New usages will emerge

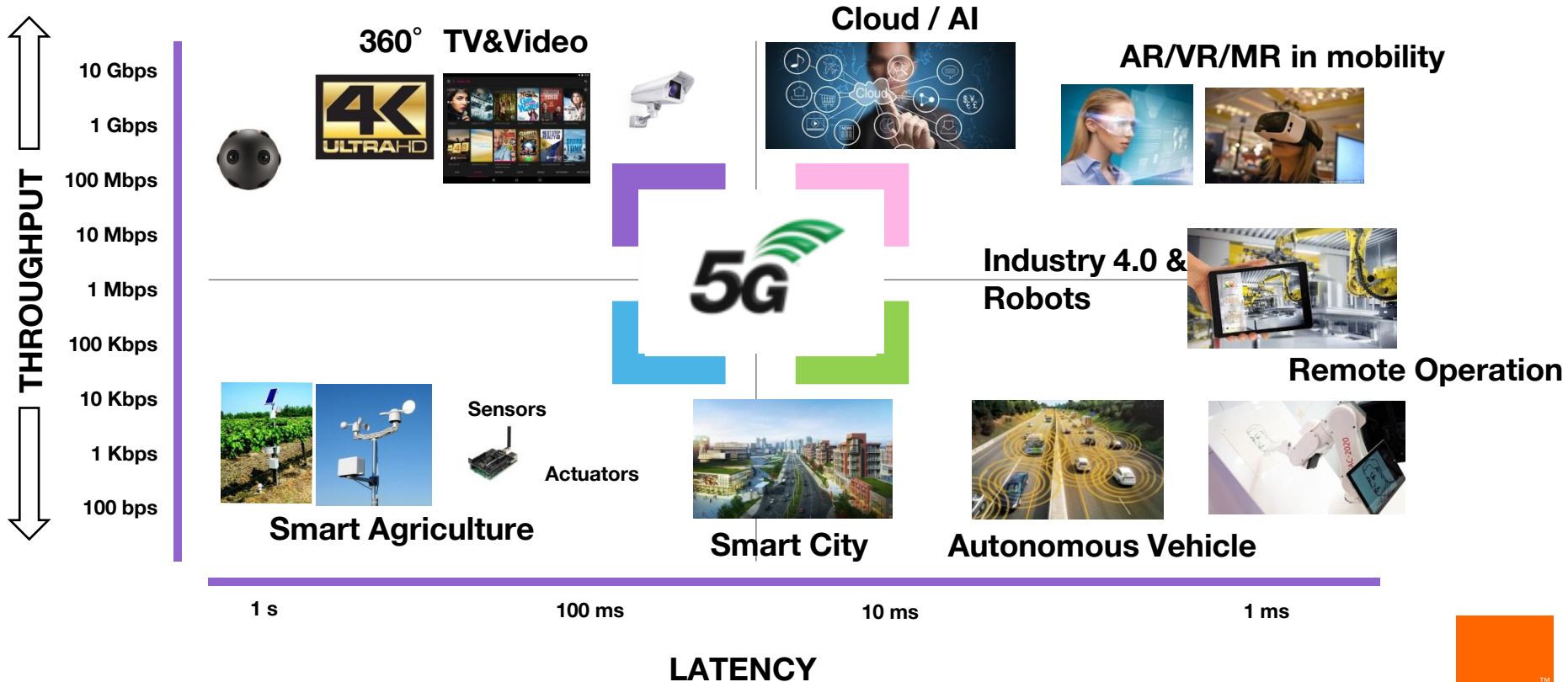

Allowing new opportunities

1

an acceleration of our **Internet of Things** diversification



2

a **fixed wireless access** to terminate fiber in suburban and rural areas



3

a reliable **LAN connectivity** for businesses



5G for Verticals: more efficiency for industries and the overall society

FACTORIES OF THE FUTURE

- 1 Time-critical process control
- 2 Non time-critical factory automation
- 3 Remote control
- 4 Intra/Inter-enterprise communication
- 5 Connected goods

ENERGY

- 1 Grid access
- 2 Grid backhaul
- 3 Grid backbone

e-HEALTH

- 1 Assets and interventions management in Hospital
- 2 Robotics
- 3 Remote monitoring
- 4 Smarter medication

MEDIA & ENTERTAINMENT

- 1 Ultra High Fidelity Media
- 2 On-site Live Event Experience
- 3 User/Machine Generated Content
- 4 Immersive and Integrated Media
- 5 Cooperative Media Production
- 6 Collaborative Gaming

AUTOMOTIVE

- 1 Automated driving
- 2 Share My View

- 3 Bird's Eye View
- 4 Digitalization of Transport and Logistics
- 5 Information Society on the road

The 5G network infrastructure: convergent and IT-ized

Distributed networking, computing and storage, enabling new services

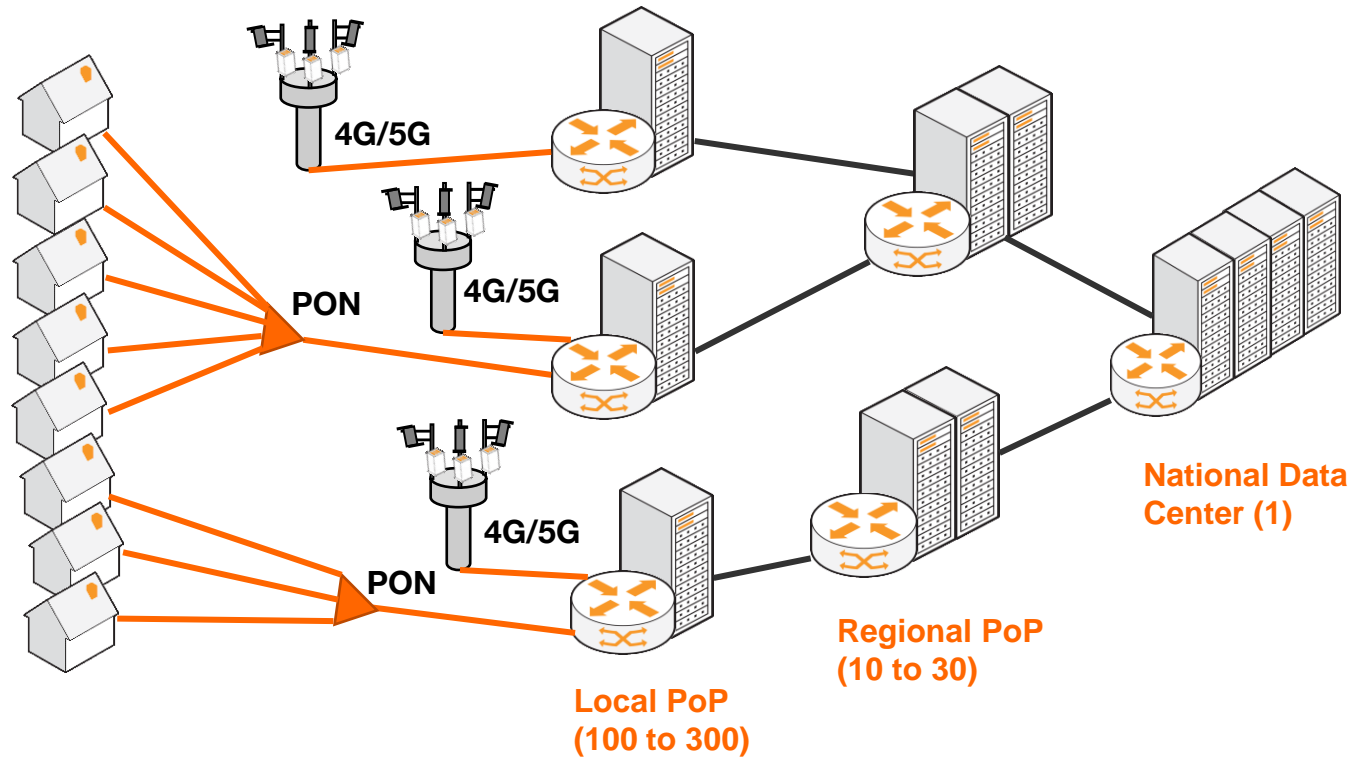

A software infrastructure delivering multiple services

5G offers the possibility to run specialised virtual networks “**network slices**” on a mutualized physical infrastructure

- slices will be established on demand, in minutes and only with the required functionalities for specific SLAs
- a mutualized infrastructure will cost less than dedicated physical networks

Slicing will enable prioritisation and QoS differentiation, as already possible in 4G

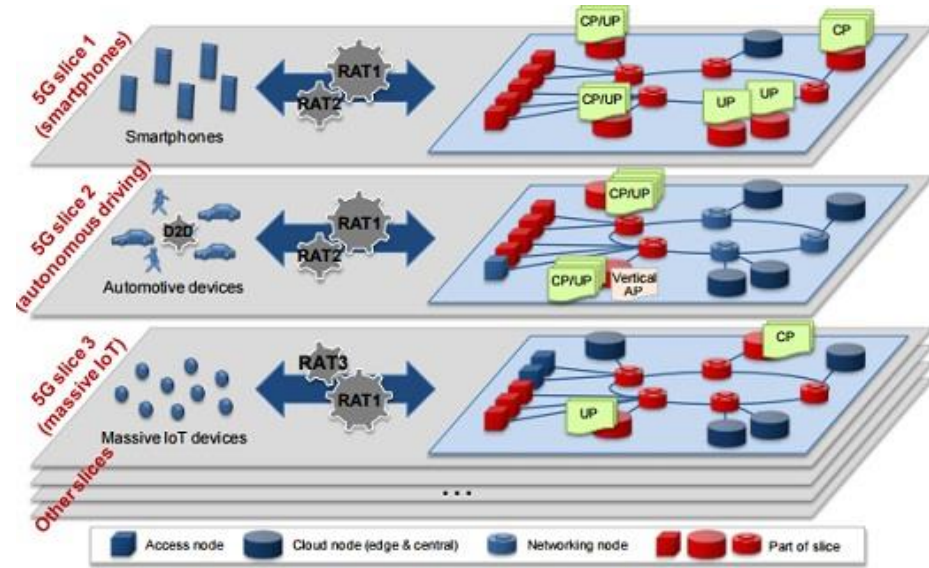

network slices: Virtual Sub-networks pre-programmed to serve specific services using dedicated or shared resources

Need for regulation to allow specialized services

Spectrum for 5G

Sufficient amounts of spectrum will be critical for the success of 5G

The bands below 6GHz will play an important role in the 5G ecosystem

- 3.4-3.8 GHz and 700 MHz bands will be Core 5G Bands for initial deployment of 5G networks
- eMBB services will require a large bandwidth in the 3.4-3.8 GHz band

The bands above 6GHz will respond capacity and performance needs

- additional bands in the 24.25-86 GHz range are expected to be identified by WRC-2019. The 24.25-27.5 GHz band is identified as pioneer band in Europe

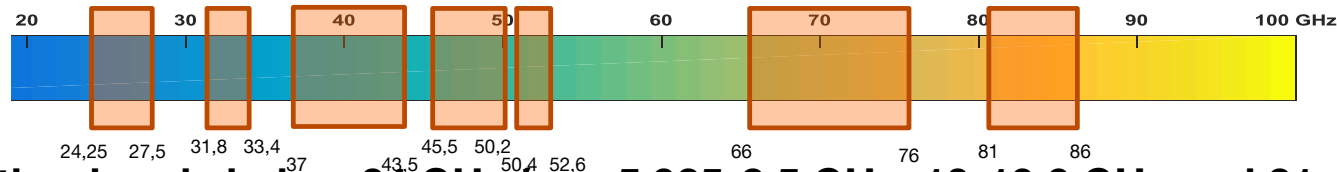

- Other bands below 24 GHz (e.g. 5.925-8.5 GHz, 10-10.6 GHz and 21.4-22 GHz), present a strong potential and could be identified on a regional basis

The 5G roadmap: from now to deployments

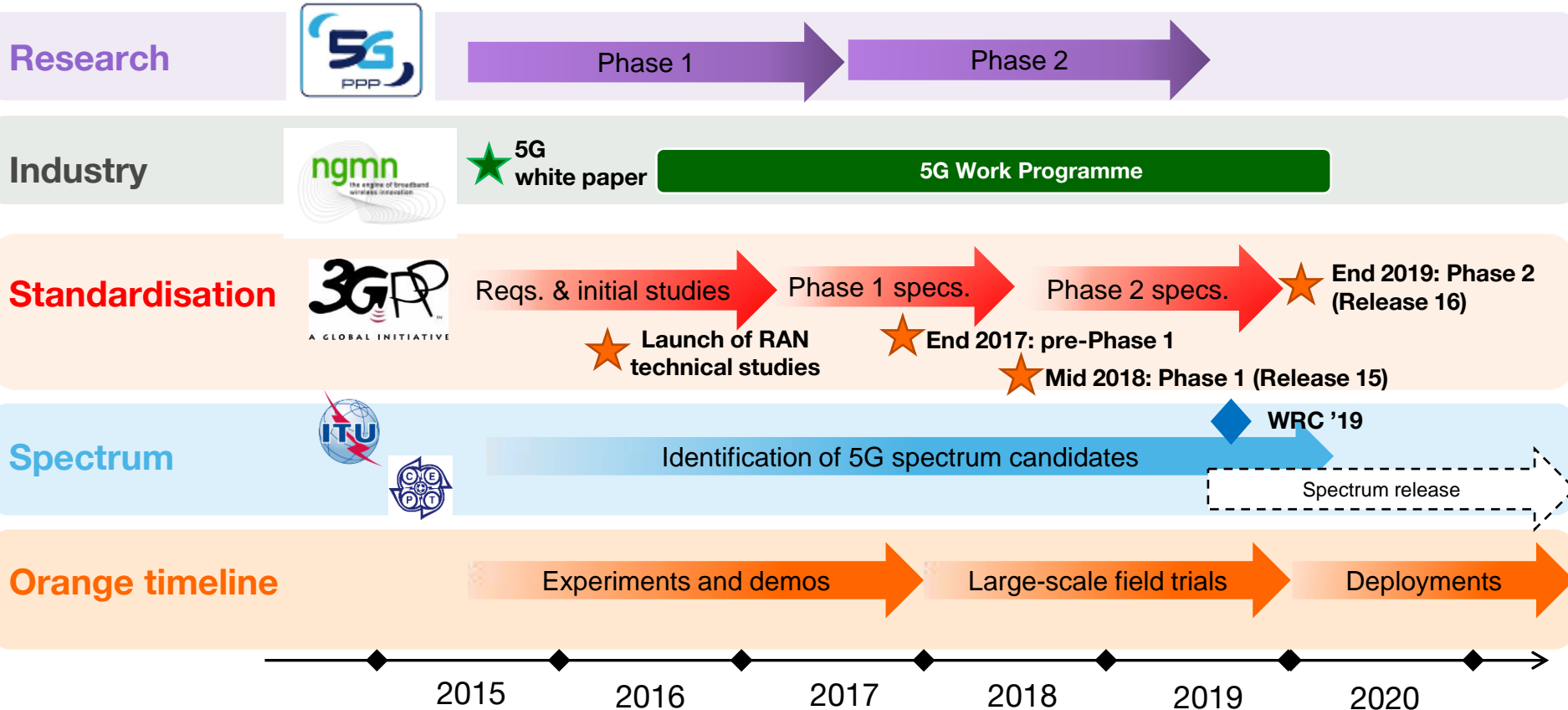

What will we have in initial deployments?

- Enhanced mobile broadband in the 3.5 GHz and 700 MHz bands
- New massive MIMO antennas, with new site architecture (RRU & antennas integrated)
- Initial ultra reliability and low latency features, depending on the market demand and equipment availability (but E2E latency dependent on the core)
- 5G core or 4G core-based architecture, depending on the country situation and equipment availability

Existing radio sites

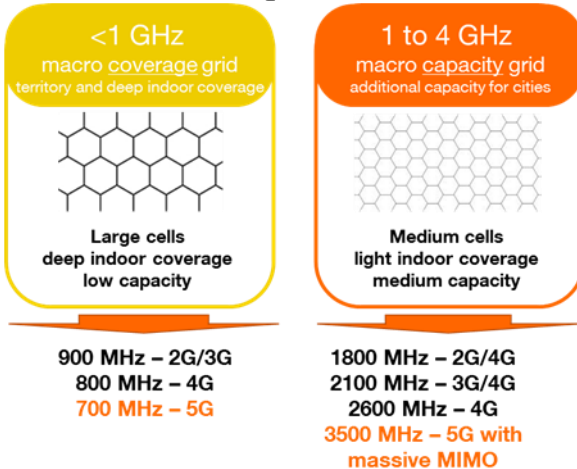

Architecture « 3x » NR Non Standalone (NSA)

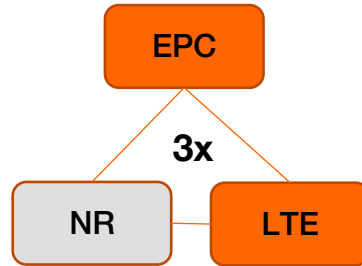

Existing Core
Dual connectivity
New Radio & LTE

Architecture « 2 » NR Standalone (SA)

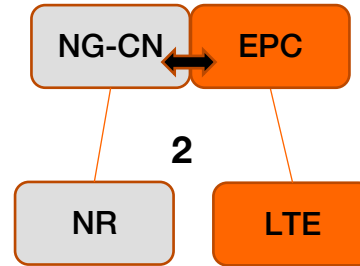

New Core
Single connectivity
New Radio or LTE

Architecture « 4x » NR Non Standalone (NSA)

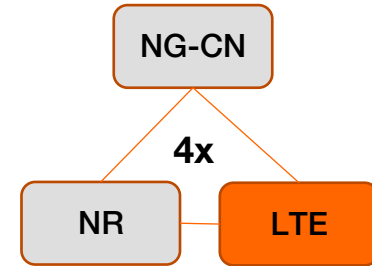

New Core
Dual connectivity
New Radio & LTE

How do we prepare for 5G?

Innovation partnerships

- 5G PPP: Orange participates in 11 projects

- Bilateral partnerships with



- Connected cars partnerships with PSA and Ericsson (Towards 5G), and with UTAC CERAM

Active contribution in standards

- 26 delegates in 3GPP, 3 in ETSI NFV, 4 in BBF
- Member of the ETSI Board, and leader of 5G Communications Topic at the Board

In industry fora (NGMN, GSMA)

- Member of the NGMN Board, leader of the 5G TTI
- Vice-chair of the GSMA Board

In regulation organisations (ITU, CEPT)



Orange propagation measurements in candidate 5G cm/mm bands, in Belfort



Towards 5G connected cars test runway

Conclusion

5G will provide an ambient and pervasive connectivity structuring the 2020-2030 digital society

- significantly enhanced mobile broadband user experience
- support of the digital transformation of vertical industries
- digital inclusion
- significantly enhanced network performance, especially energy efficiency

Initial commercial services from 2020 with first functionalities

- Enhanced mobile broadband in the 3.5 GHz and 700 MHz bands
- Initial ultra reliability and low latency features, depending on country situation
- Uncertainty around the deployment of the 5G core and slicing in 2020

Collaboration with the future users is essential for the 5G success

- for the telecom industry to understand the customers technical requirements
- to prepare the 5G ecosystem and business models

Thank you

